

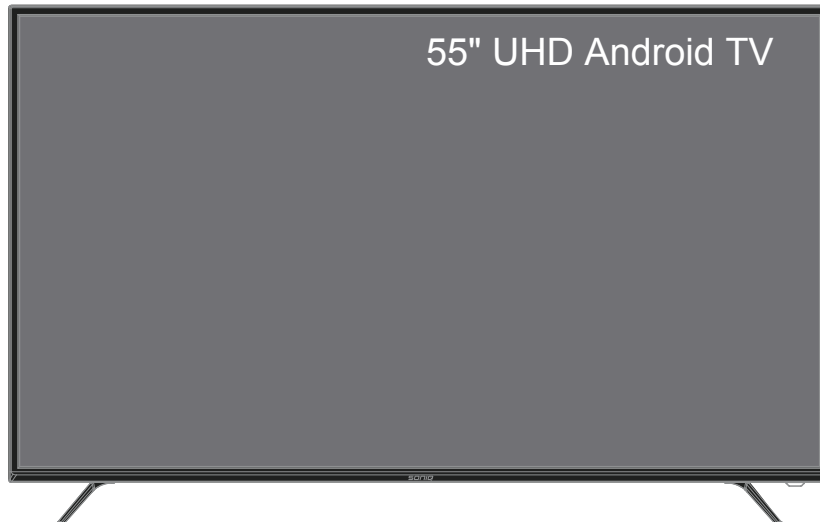

Instruction Manual



G55UW40A



CONTENTS

CAUTION	2
ACCESSORY	4
STAND ASSEMBLY	5
CONTROL BUTTON	6
TERMINAL	7
REMOTE CONTROLLER	8
INITIAL SETUP	10
MENU OPERATION	11
SPECIFICATIONS	19
SIMPLE TROUBLESHOOTING	20

CAUTION

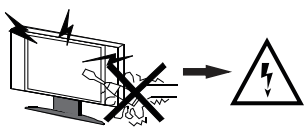
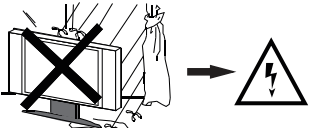
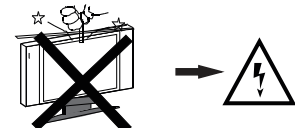
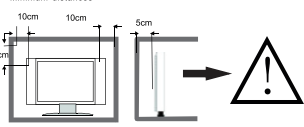
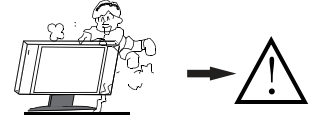
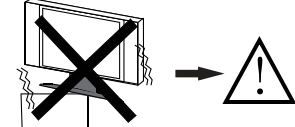

1. **Read Instructions** - All the safety and operating instructions should be read before the appliance is operated.
2. **Retain Instructions** - The safety and operating instructions should be retained for future reference.
3. **Heed Warnings** - All warnings on the appliance and in the operating instructions should be adhered to.
4. **Follow Instructions** - All operating instructions should be followed.
5. **Battery** - Batteries shall not be exposed to excessive heat such as sunshine, fire or the like.
6. **Earthing Connection** - The apparatus shall be connected to a MAINS socket outlet with a protective earthing connection.
7. **Water and Moisture** - The appliance should not be used near water.
8. **Cart and Stands** - The appliance should only be used with a cart or stand that is recommended by the manufacturer.
9. **Wall or Ceiling Mounting** - The appliance should be mounted to a wall or ceiling only as recommended by the manufacturer.
10. **Ventilation** - The appliance should be well situated so that its location or position does not interfere with its proper ventilation.
11. **Heat** - This appliance should be placed away from heat sources such as radiators, heat registers and stoves.
12. **Power Sources** - The appliance should only be connected to a power supply as described in the operating instructions or as marked on the appliance.
13. **Grounding or Polarization** - Precautions should be taken.
14. **Power Cord Protection** - Power supply cord should be located so that it is not likely to be walked on, or pinched by items placed upon it.
15. **Cleaning** - The appliance should be cleaned only as recommended by the manufacturer.
16. **Power Lines** - An outdoor antenna should be located away from power lines.
17. **Outdoor Antenna Grounding** - If an outside antenna is connected to the receiver, the antenna system must be grounded so as to provide against voltages and built-up static charges.
18. **Non-use Periods** - The power cord of the appliance should be unplugged from the outlet when left unused for a long period of time.
19. **Objects and Liquids** - Care should be taken so that objects do not fall, and liquids are not spilled into the enclosure through openings.
20. **Conditions Requiring Service** - The appliance should be serviced by qualified service personnel when:
 - The power-supply cord or the plug has been damaged.
 - Objects have fallen on or liquid has been spilled into the appliance.
 - The appliance has been exposed to rain.
 - The appliance does not appear to operate normally or exhibits a marked change in performance.
21. This appliance should not be exposed to water and no objects filled with liquids such as a vase should be placed on the unit. Where the mains plug or an appliance coupler is used as the disconnect device, the disconnect device shall remain readily operable.

 <p>Warning High voltages are used in the operation of this product. Do not remove the back cover of the cabinet. Refer servicing to qualified service personnel.</p>	 <p>Warning To prevent fire or electrical shock hazard, do not expose the main unit to rain or moisture.</p>	 <p>Warning Do not insert foreign objects into the television's slots or openings. Never spill any kind of liquid on the television receiver.</p>
 <p>Caution If the television is placed into a confined space, ensure that the minimum distances are observed as shown. Heat build up can reduce the service life of your television, and can also be dangerous.</p>	 <p>Caution Never stand on, lean on, push or apply force to the product or its stand. You should pay special attention to children.</p>	 <p>Caution Do not place the main unit on an unstable cart stand, shelf or table. Serious injury to an individual, and damage to the television, may result should it fall.</p>

CAUTION

Best Practice Guide For Furniture And Television Tip-over Prevention

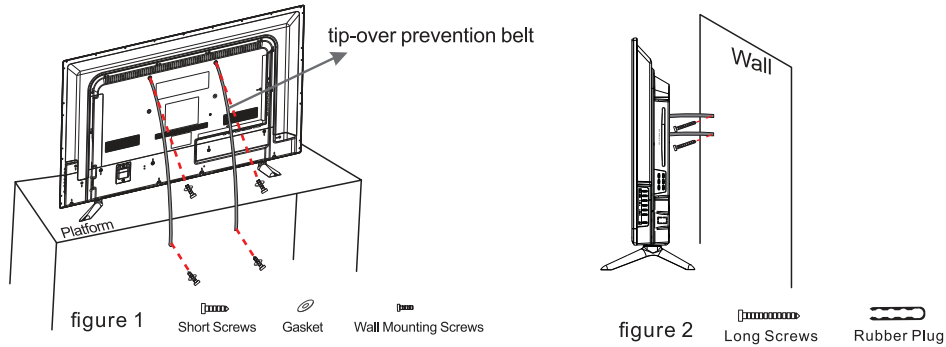

- Put the TV on the platform, fix one end of the tip-over prevention belt in the TV wall mounting hole with screw. Then fix the other end of the tip-over prevention belt on the platform or other suitable surface with screw. (Choose the suitable screws according to the TV size and model to fix the screw in the TV wall mount hole).
- The wall anchor should be fixed on the wall or other surface permanently, screw fixed in the wall must be put into the rubber plug to avoid breaking the TV and cause server personal injury. (figure 2).
Attention: Check whether the tip-over prevention belt is fixed firmly after installation to avoid accident occurring. The screws fixed in the platform or wall are included in the accessory bag.

Exemptions

- SONIQ is not liable for any damage caused by fires, natural disaster (such as thunderstorms, earthquake, etc.), acts by the third parties, accidents, owner's misuse or use in other improper conditions.
- SONIQ is not liable for incidental damages (such as profit loss or interruption in business, modification or erasure of record data, etc.) caused by use or inability to use of product.
- SONIQ is not liable for any damage caused by neglect of the instructions described in the owner's manual.
- SONIQ is not liable for any damage caused by misuse or malfunction through simultaneous use of this product and the connected equipment.

Introduction

Thank you for purchasing the unit. Your unit will bring you years of high-quality viewing enjoyment. The television is easy to operate and provides exceptionally high quality image. The manual will explain the operation of the unit, including its functions, features and other important features. Before installing or operating your unit, please take the time to thoroughly read this manual, particularly the sections on safety.

ACCESSORY

Note:

There are these accessories in the carton, the style will be different according to the product model.

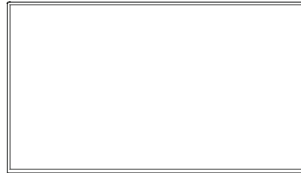

Main Unit

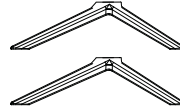

Stand



Remote Control
AAA Batteries(x2)

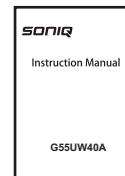

Instruction Manual



Screws: BB4*14 (X6)



Warranty Card

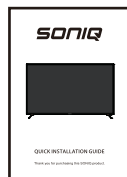

Quick installation manual



Tipping prevention materials

STAND ASSEMBLY

1. Please disconnect all the cable connections before installation.
2. Lay the TV face down on a flat surface, on a blanket or towel to avoid damaging the screen.
3. Please keep the TV in a horizontal position and fix the standing base with screws.

Note:

- Only use matching screws provided by manufacturer in the accessory bag to install the stand of TV unit, in order to avoid damaging the TV unit.

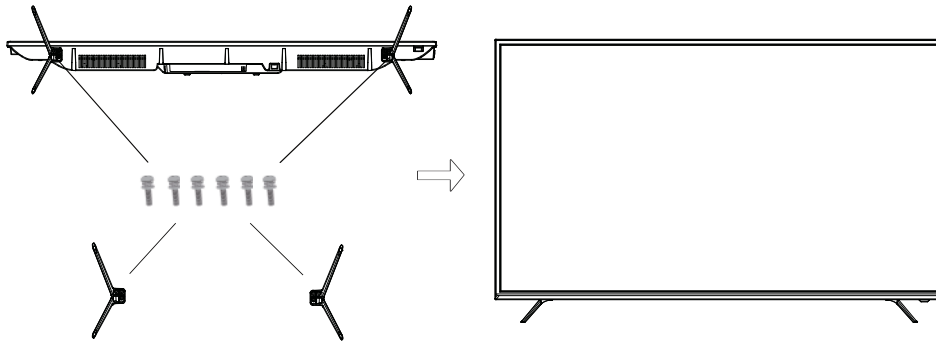

Wall Mounting Instruction:

This TV is equipped with mounting holes of 200 x 200mm. If the thickness of the wall mount is 2mm, 4PCS of type M6x10mm screws are required (the length of the screws fixed in the interior of the TV should not be longer than 12mm). Recommend to use SONIQ wall mount and install by professional people (do not operate while the TV is on).

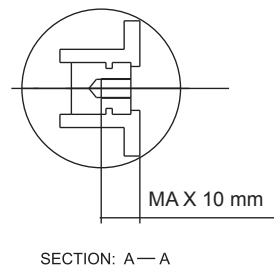
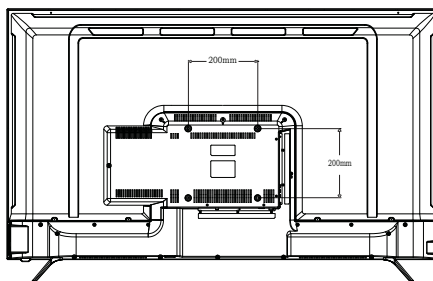

CONTROL BUTTON

Note:

The following is only functional schematic, And the actual position and arrangement of different models may be different. Some models has 5 buttons, some models has 7 buttons.

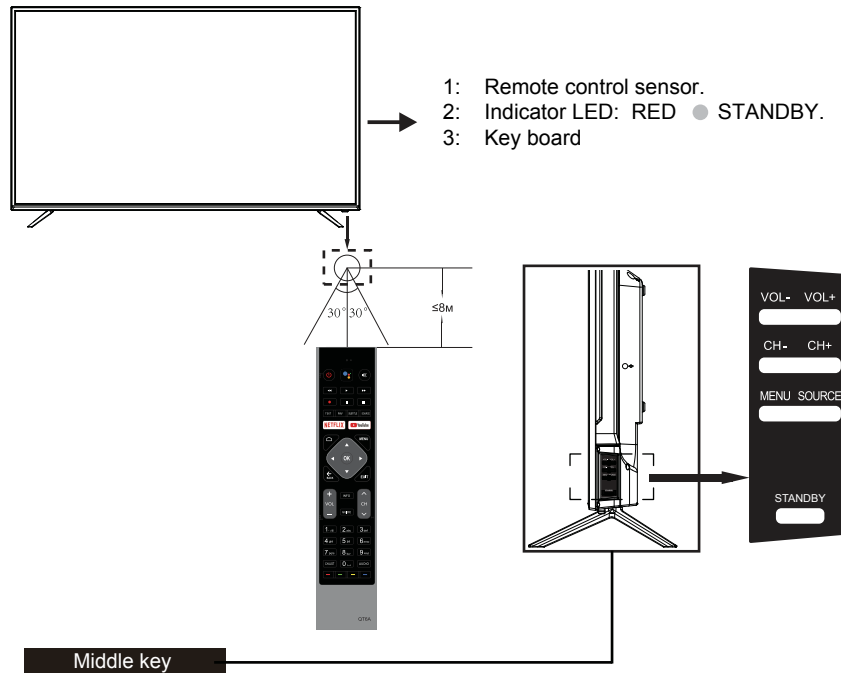

In the standby state, press the STANDBY button to turn on the TV; in the startup state, short press the STANDBY button to turn off.

To adjust the volume, press the VOL +-key, and to change the channel, press the CH +- key.

To open the setup menu, please press the MENU button, SOURCE to switch the signal source.

TERMINAL

The LED TV has many multimedia functions. It can be connected to many types of equipment. The following paragraph shows how to connect to other Audio and Video devices.

REAR AV Connections (SIDE)

All the terminals are (from left to right):
HDMI4(ARC), ANT IN, USBTF, EARPHONE, YPbPr Input.

REAR AV Connections

USBAll the terminals are (from left to right):
RJ45, OPTICAL output, AUDIO input(L/R), VIDEO, HDMI1, HDMI2, , HDMI3.

Note: VIDEO and YPbPr share one audio channel. When HDMI port get DVI signal, the audio signal receives from the AV Audio channel.

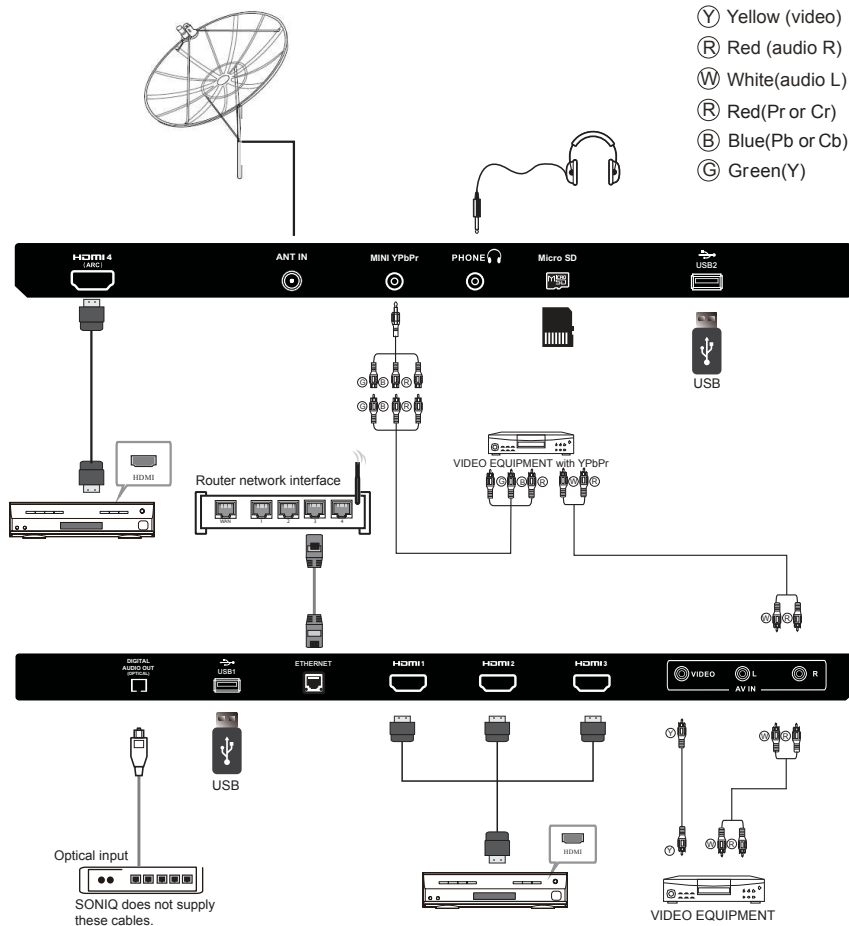

REMOTE CONTROLLER

The remote controller cannot be used unless it is within the receivable range. Before you use the remote control, please make sure there's no obstacle between the remote control and the receiver.











- Open the battery cover and insert 2 "AAA" batteries.
- Point the remote control at the remote sensor located on the unit.
- When there is a strong ambient light source, the performance of the infrared remote sensor may be degraded, causing unreliable operation.
- The recommended effective distance for remote is about 16 feet (5 meters).
- When the batteries become weak and the operating distance of the remote control is greatly reduced, you will need to replace the batteries.
- If the remote control is not going to be used for a long period of time, remove the batteries to avoid damage caused by battery leakage or corrosion.
- Do not mix old and new batteries or ALKALINE or standard (CARBON-ZINC) or rechargeable (NICKEL-CADMIUM) batteries.
- Always remove batteries as soon as they become weak.
- Weak batteries can leak and severely damage the remote control.
- Do not dispose of batteries in fire, they may explode or leak.
- Batteries should not be exposed to excessive heat such as sunshine, fire or the like.



CAUTION :
Danger of explosion may occur if battery is incorrectly replaced.

REMOTE CONTROLLER

#	Item	Descriptions
1	 Power	Press to turn the TV on or off. When your TV is off, power still flows through it. To completely disconnect power, unplug the power cord.
2	 MUTE	Press to switch the sound on or off.
3	Google Assistant	launches the built-in virtual assistant.
4	 (reverse)	Press to reverse playback in multimedia & Timeshift mode.
5	 (play)	Press to play in multimedia mode & Timeshift mode.
6	 (forward)	Press to fast forward in multimedia & Timeshift mode.
7	 (REC)	Press to record the TV program you are watching in DTV mode.
8	 (Pause)	Press to pause in multimedia mode & Timeshift mode.
9	 (stop)	Press to stop multimedia playback, REC & Timeshift mode.
10	TEXT	Press to select the teletext mode.
11	FAV	Press to select or remove your favorite channel.
12	SUBTITLE	Open or close subtitle.
13	SOURCE	Press to open the input source list.
14	NETFLIX	Press to open the NETFLIX.
15	YouTube	Press to open the YouTube.
16	HOME	Press to open the Home Page.
17	MENU	Press to open or close the on-screen menu.
18		Press to navigate the on-screen menu.
19	OK	Enter the selected option or perform the selected operation.
20	BACK	Return to the previous menu.
21	EXIT	It depends on the actual function
22	INFO	Press to display the channel information.
23	GUIDE	Press to display electronic programme guide in TV mode.
24	VOL+/VOL-	Press VOL+ or VOL- to adjust volume level.
25	CH+/CH -	Press CH+ or CH- to change TV channels.
26	0~9 number	Press to enter a TV channel number.
27	CH.LIST	Press to display the Channel List.
28	AUDIO	Press to select Mono, Nicam, Stereo for ATV channel, Audio language for DTV channel.
29	Coloured buttons	Implement the relevant operations according to the prompt at the bottom of the menu in the text.

INITIAL SETUP

The first time you turn on your TV, the setup wizard will guide you through setting up basic settings. Please according to the Text Tip to First Time Setup.

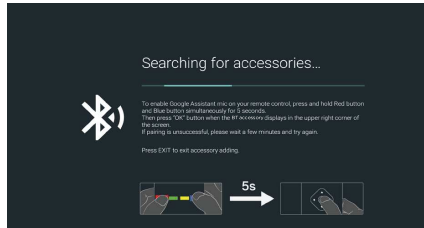

This function is used for the remote control pair code. After the code is successful, you can use the Bluetooth remote control to operate the TV.
Note : It is only available to the remote control with Bluetooth.

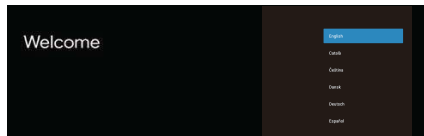

Press ▲/▼ to select the system language and press **OK** to confirm the language.



Connect your Android phone to your TV, select "Continue" to continue the connection, and choose "Skip" to skip this step.



Press ▲/▼ to select the wifi to connect, press **OK** and enter the password to confirm the connection is successful.

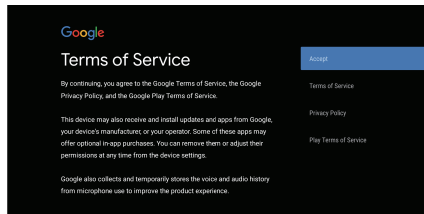

By accepting the Google Terms of Service to improve the product experience, select "Accept" to accept this condition.

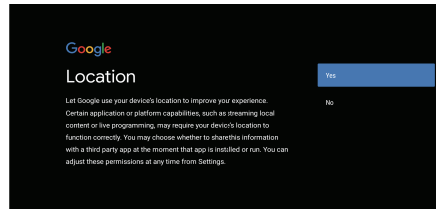

Agree to Google to get the location information of your device to get more features, choose "YES" to accept.

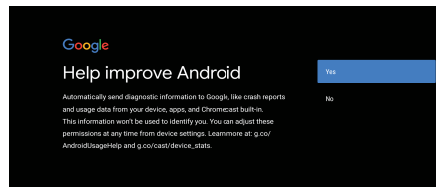

By agreeing to automatically send diagnostic information to Google to improve discriminative power, choose "YES" to accept.

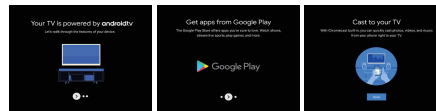

1. Your device is powered by Android TV and press the ► button to select the browsing feature.
2. You can get more apps from Google Play and press the ► button to go to the next screen.
3. Transfer photos and other content to the TV via the built-in chromecast, press **OK** to complete the browsing.

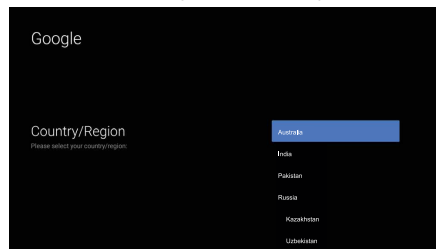

Press ▲/▼ to select the country of your device and press **OK** to confirm.

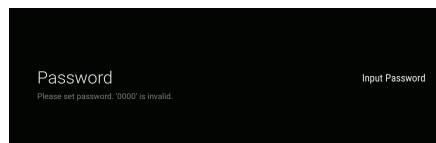

Used to set your device's password to ensure security and privacy.

MENU OPERATION



Press **OK** to pop up the soft keyboard, and use the remote control to enter the 4-digit password automatically jump to the next interface.



Confirm the password again and keep it consistent. Use the remote control to enter the password and complete the password confirmation.

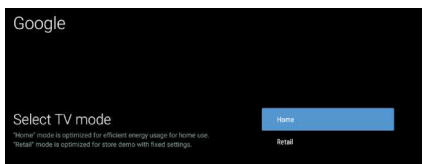

For selecting the mode, press **▲/▼** key to select Home mode and press **OK** to confirm.

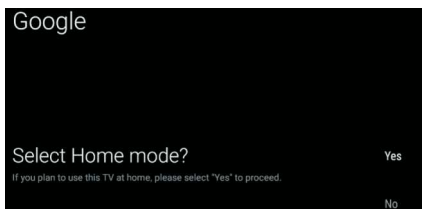

Confirm the selected mode again, select "Yes" to confirm the selected mode, and select "No" to return to the previous step.

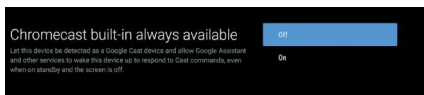

Press **▲/▼** to turn on or off the always available features of Chromecast.

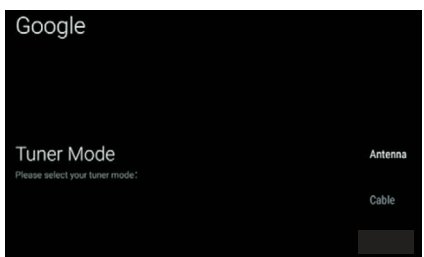

To select the Tuner mode for searching, press **▲/▼** to select and press **OK** to confirm.

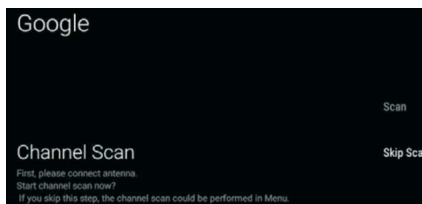

Press **▲/▼** to select whether to search, select "Scan" to search, select "Skip scan" to skip the search.

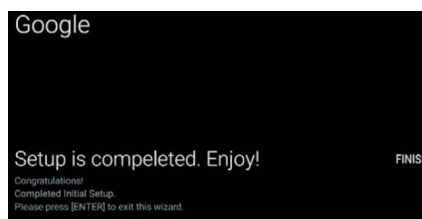

Press **OK** to complete the setup.

HOME SCREEN

After completing the wizard Settings, you can watch TV and go to the home screen.

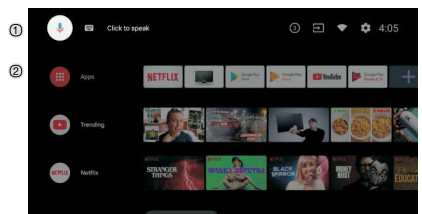

- ① Open Google Assistant or start a voice search.
- ② Among the applications installed on the TV, the icons for the favourite applications are shown inside here. (Favourite applications can be added/deleted changed its order by users.)
- 📱 **Apps:** Click to jump to Apps screen where all the installed applications are listed.
- ③
- 🔔 **Notification:** Display the notifications.
- 📺 **Inputs:** Icon to select an input source.
- 🌐 **Network&Internet:** Icon to Set up Network, Such as wifi.
- ⚙️ **Settings:** Various settings can be configured here. For details on the settings, see the next explanation.

MENU OPERATION

INPUT SOURCE

1. In the HOME interface, press ▲/▼/◀/▶ to select the "Inputs" icon, press **OK** to open the input source list, then press up to highlight an input and press **OK** to switch.

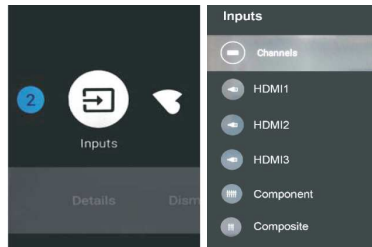

2. Under live TV, press the **SOURCE** button to display the list of input sources. You can select the desired source.

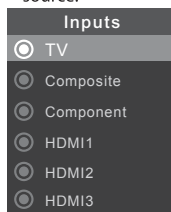

NAVIGATING THE ON-SCREEN MENU

1. There are two ways to enter. First, in live TV, press the menu button to display TV options, press ▲/▼/◀/▶ to select the settings menu and press **OK** to confirm. Second, in the HOME interface, press the ► key to select the icon of the circular settings menu, press **OK** to confirm.

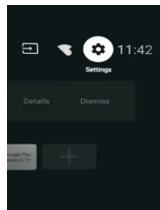
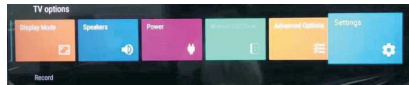

2. Press ▲/▼ button to select what you want set.
3. Press **OK** to enter setting.

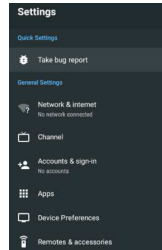

Press **BACK** to return to the previous menu. If the main menu is displayed, pressing **BACK** will close the onscreen menu.

Network

1. Press ▲/▼ button to select what you want set .
2. Press **OK** button to adjust.
3. After finishing your adjustment, Press **OK** button to save and return to the previous menu.

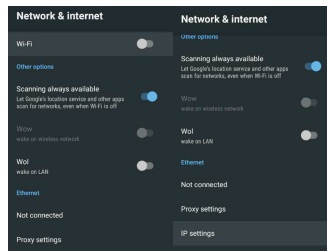

CHANNEL

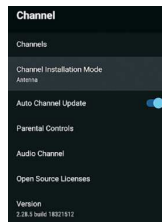

Channels – Display the scan **sub-menu** based on different Channel installation modes.

Channel installation mode – Select on-screen display channel sources. You can select the signal type.

- **Antenna** – Set the signal type to antenna. When set to Antenna, the TV can receive analog and digital (DVBT/T2) broadcasting signals.
- **Cable** – Set the signal type to cable. When set to Cable, the TV can receive analog and QAM broadcasting signals.

MENU OPERATION

• **Preferred Satellite/General Satellite** – Set the signal type to Satellite. When set to Satellite, the TV can receive Satellite broadcasting signals.

Auto Channel Update – Press OK button to choose ON/OFF. When selecting ON, the system will automatically scan and update channels after 5 minutes of standby.

Parental controls – Press ▲/▼ button to select the option then press OK button to enter the sub-menu.

Audio Channel – Press ▲/▼ button to select the option then press OK button to enter the sub-menu.

Open source licenses – Press ▲/▼ button to select the option then press OK button to enter the sub-menu.

Antenna

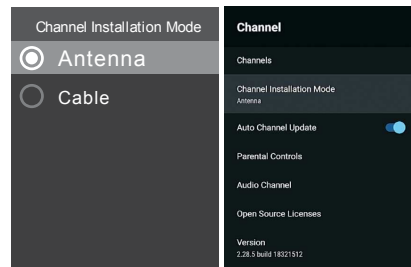

1. Menu->Settings->Channel->Channel Installation Mode enter, choose Antenna.

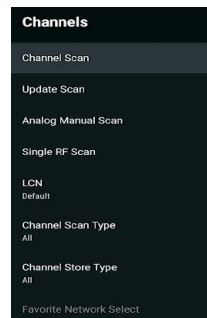

2. Enter Menu->Settings->Channel->Channels.

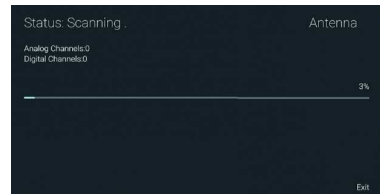

3. Channel Scan directly enters the ATV+DTV automatic search platform interface of Antenna.

Update Scan: Re-automatically search for frequency points outside the station.

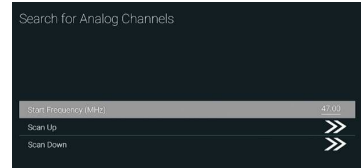

Analog Manual Scan: Manual ATV search station. After input the frequency point, you can select up or down search station.



Single RF Scan: DTV manual search, left and right after selecting RF Channel, directly OK search.

Cable



1. Menu->Settings->Channel->Channel Installation Mode, select Cable.

2. Enter Menu->Settings->Channel->Channels

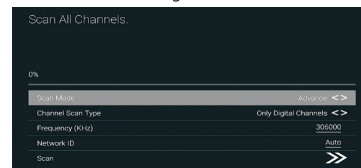

3. Enter Channel Scan, where Akado, Divan TV, Online and Rostelecom (SPB) are the local operators, and the default Scan Mode is Advance; Others have Advance, Quick and Full Scan modes.

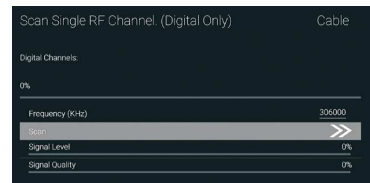

MENU OPERATION

APPS

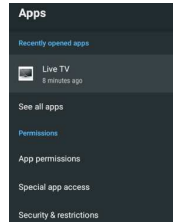

In this menu, you can set the APP permissions, and read the app lists

1. Press ▲/▼ button to select what you want set.
2. Press OK button to adjust.
3. After finishing your adjustment, Press BACK button to return to the previous menu.

DEVICE PREFERENCES

ABOUT

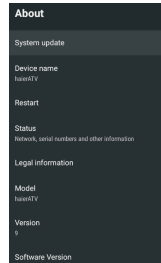

In this menu, you can read the information and settings of TV.

1. Press ▲/▼ button to select what you want set.
2. Press OK button to adjust.
3. After finishing your adjustment, Press BACK button to return to the previous menu.

DATE&TIME

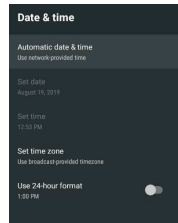

Automatic date & time – Press ▲/▼ button to select the option then press OK button to enter the sub-menu. (Optional: Use network-provided time, Off)

NOTE

- Manually adjusting date & time settings will automatically change the **Automatic date & time** to OFF.

Set date – Press ▲/▼ button to select the option then press OK button to enter the sub-menu.

Set time – Press ▲/▼ button to select the option then press OK button to enter the sub-menu.

Set time zone – Press ▲/▼ button to select the option then press OK button to enter the sub-menu.

Use 24-hour format – Press ▲/▼ button to select the option then press OK button to choose ON/OFF.

TIME

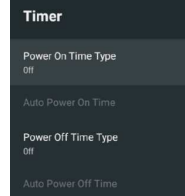

Power On Time Type – Press ▲/▼ button to select the option then press OK button to choose ON/OFF/ONCE.

Auto Power On Time – Press ▲/▼ button to select the option then press OK button to enter the sub-menu. (This option is valid when the **Power On Time Type** is selected as On /ONCE.)

Power Off Time Type – Press ▲/▼ button to select the option then press OK button to choose ON/OFF/ONCE.

Auto Power Off Time – Press ▲/▼ button to select the option then press OK button to enter the sub-menu. (This option is valid when the **Power Off Time Type** is selected as On /ONCE.)

LANGUAGE

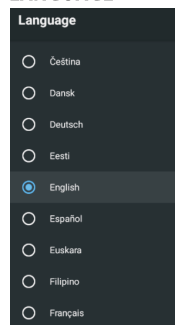

Language – Press ▲/▼ button to select the option then press OK button to enter the select language.

MENU OPERATION

KEYBOARD



Current keyboard – Press ▲/▼ button to select the option then press **OK** button to enter the sub-menu.

Gboard Settings – Press ▲/▼ button to select the option then press **OK** button to enter the sub-menu.

Manage keyboards – Press ▲/▼ button to select the option then press **OK** button to enter the sub-menu.

INPUTS

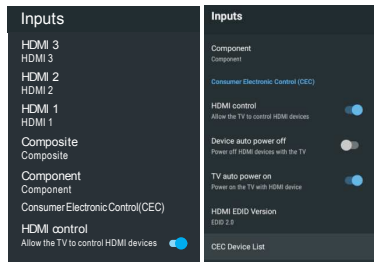

Inputs – Press ▲/▼ button to select the option then press **OK** button to enter the sub-menu.

HDMI control – Press ▲/▼ button to select the option then press **OK** button to choose ON/OFF.

Device auto power off – Press ▲/▼ button to select the option then press **OK** button to choose ON/OFF.

TV auto power on – Press ▲/▼ button to select the option then press **OK** button to choose ON/OFF.

HDMI EDID Version – show EDID version.

CEC Device List – Press ▲/▼ button to select the option then press **OK** button to enter the sub-menu.

POWER

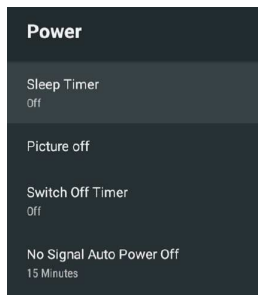

Sleep Timer – Press ▲/▼ button to select the option then press **OK** button to enter the sub-menu. (Optional: off, 10 minutes, 20 minutes, 30 minutes, 40 minutes, 50 minutes, 60 minutes, 90 minutes, 120 minutes).

Picture off – Press ▲/▼ button to select the option then press **OK** button to choose ON/OFF.

Switch off timer – Press ▲/▼ button to select the option then press **OK** button to enter the sub-menu. (Optional: off, 30 minutes, 60 minutes, 90 minutes, 120 minutes, 150 minutes, 180 minutes, 210 minutes, 240 minutes)

No Signal Auto Power Off – Press ▲/▼ button to select the option then press **OK** button to enter the sub-menu. (Optional: off, 5 minutes, 10 minutes, 15 minutes, 30 minutes, 60 minutes).

PICTURE

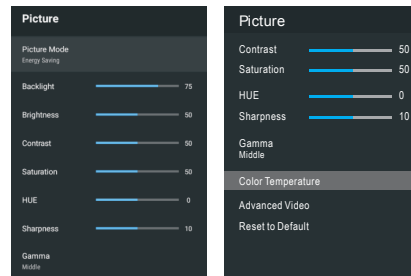

Picture Mode – Press ▲/▼ button to select the option button to enter the sub-menu. (Optional: user, Standard, Vivid, Sport, Movie, Game, Energy saving).

Backlight/Brightness/Contrast/Saturation/HUE/Sharpness – Press ▲/▼ button to select the option. Press ◀ to decrease the parameter. Press ▶ to increase the parameter.

Gamma – Press ▲/▼ button to select the option then press **OK** button to enter the sub-menu. (Optional: Dark, middle, Bright).

Color Temperature – Press ▲/▼ button to select the option then press **OK** button to enter the sub-menu.

Advanced Video – Press ▲/▼ button to select the option then press **OK** button to enter the sub-menu.

Reset to Default – Reset all settings to the factory defaults.

MENU OPERATION

SOUND

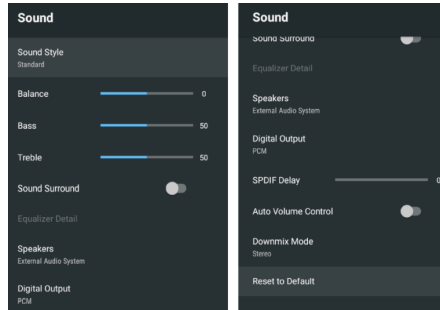

Sound style – Press ▲/▼ button to select the option then press **OK** button to enter the sub-menu. (Optional: user, Standard, Vivid, Sports, Movie, Music, News).

Balance/Bass/Treble – Press ▲/▼ button to select the option. Press ◀ to decrease the parameter. Press ▶ to increase the parameter.

Sound Surround – Press ▲/▼ button to select the option then press **OK** button to choose ON/OFF.

Equalizer Detail – Press ▲/▼ button to select the option then press **OK** button to enter the sub-menu.

Speakers – Press ▲/▼ button to select the option then press **OK** button to enter the sub-menu. (Optional: TV Speaker, External Audio System).

Digital Output – Press ▲/▼ button to select the option then press **OK** button to enter the sub-menu. (Optional: Auto, Bypass, PCM, Dolby Digital Plus, Dolby Digital).

SPDIF Delay – Press ▲/▼ button to select the option. Press ◀ to decrease the parameter. Press ▶ to increase the parameter.

Auto Volume Control – Press ▲/▼ button to select the option then press **OK** button to choose ON/OFF.

Downmix Mode – Press ▲/▼ button to select the option then press **OK** button to enter the sub-menu. (Optional: Stereo, Surround).

Reset to Default – Reset all settings to the factory defaults.

STORAGE

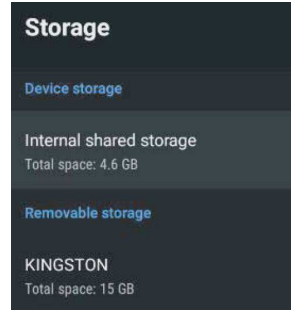

Internal shared storage – Press ▲/▼ button to select the option then press **OK** button to enter the sub-menu.

Removable Storage – Press ▲/▼ button to select the option then press **OK** button to enter the sub-menu. (Note: Show external devices if available)

HOME SCREEN

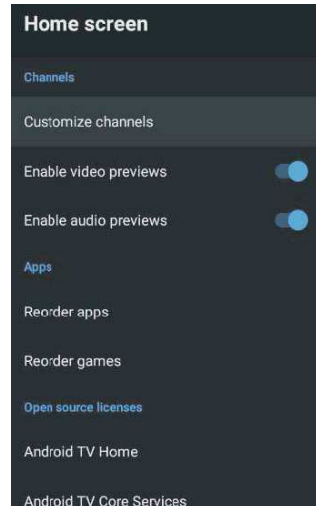

In this menu, you can set channels, apps, open source licenses.

1. Press ▲/▼ button to select what you want set.
2. Press **OK** button to adjust.
3. After finishing your adjustment, Press **BACK** button return to the previous menu.

MENU OPERATION

RETAIL MODE

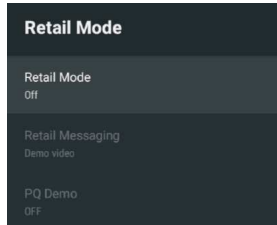

Retail mode – Press ▲/▼ button to select the option then press **OK** button to choose ON/OFF.

Retail messaging – Press ▲/▼ button to select the option then press **OK** button to enter the sub-menu. (Note: Demo video, e-POP left, e-POP bottom)

PQ Demo – Press ▲/▼ button to select the option then press **OK** button to enter the sub-menu. (Note: OFF, LEFT, RIGHT)

GOOGLE

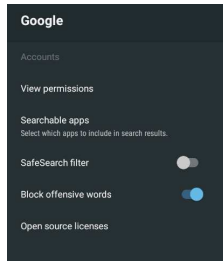

In this menu, you can set searchable apps, safe search filter, block offensive words, open source licenses.

1. Press ▲/▼ button to select what you want set.
2. Press **OK** button to adjust.
3. After finishing your adjustment, Press **BACK** button return to the previous menu.

CHROMECASTBUILT-IN

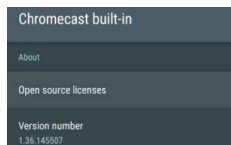

In this menu, you can read the information and settings of Chromecast

1. Press ▲/▼ button to select what you want set.
2. Press **OK** button to adjust.
3. After finishing your adjustment, Press **BACK** button return to the previous menu.

SCREEN SAVER

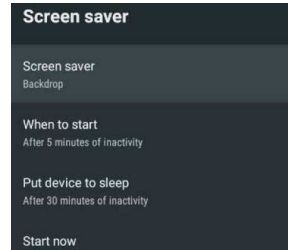

Screen saver – Press ▲/▼ button to select the option then press **OK** button to enter the sub-menu.

(Optional: Turn screen off, Backdrop, Colors)

When to Start – Press ▲/▼ button to select the option then press **OK** button to enter the sub-menu. (Optional: 5 minutes, 15 minutes, 30 minutes, 1 hour, 2 hours).

Put device to sleep – Press ▲/▼ button to select the option then press **OK** button to enter the sub-menu. (Optional: 30 minutes, 1 hour, 3 hours, 6 hours, 12 hours, Never).

Start now – Press ▲/▼ button to select the option then press **OK** button to enter screen saver.

LOCATION

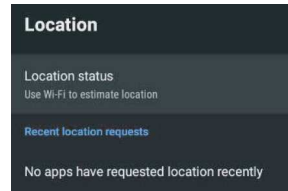

Location status – Press ▲/▼ button to select the option then press **OK** button to enter the sub-menu.

(Optional: Use Wi-Fi to estimate location, Off)

USAGE & DIAGNOSTICS

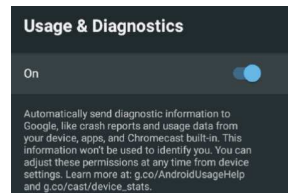

Usage & diagnostics – Press ▲/▼ button to select the option then press **OK** button to choose ON/OFF

MENU OPERATION

ACCESSIBILITY

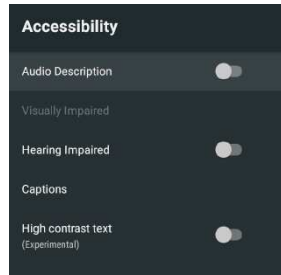

Audio Description- Press ▲ / ▼ button to select the option then press **OK** button to choose ON/OFF.

Visually Impaired – Press ▲ / ▼ button to select the option then press **OK** button to enter the sub-menu. (Need: **Audio Description**) ON

Hearing Impaired – Press ▲ / ▼ button to select the option then press **OK** button to choose ON/OFF.

Captions – Press ▲ / ▼ button to select the option then press **OK** button to enter the sub-menu

High contrast text – Press ▲ / ▼ button to select the option then press **OK** button to choose ON/OFF.

RESET

Press **OK** button to enter the sub-menu.
Reset-Erase everything.

REMOTE&ACCESSORIES

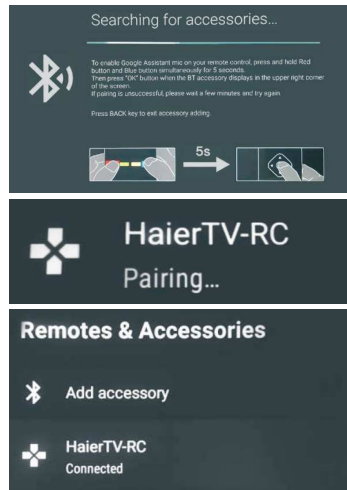

Note: It is only available to the remote control with Bluetooth.

1. Press the **"RED"** and **"BLUE"** buttons at the bottom of the remote control for 5 seconds.
2. When the LED starts to flash, release it. The remote controller will send the pairing signal to the TV and display the information of the remote control on the right side of the screen.
3. Press the **OK** button to display the pairing. If the paired is displayed, the connection is successful.
4. If the couldn't pair appears, the connection fails. Wait 30 seconds and then press the **"RED"** and **"BLUE"** buttons at the bottom of the remote control for 5 seconds to repeat the previous steps.
5. Press **EXIT** or **BACK** button return to the previous menu.

ADD AND USE OF MULTI MEDIA PLAYER

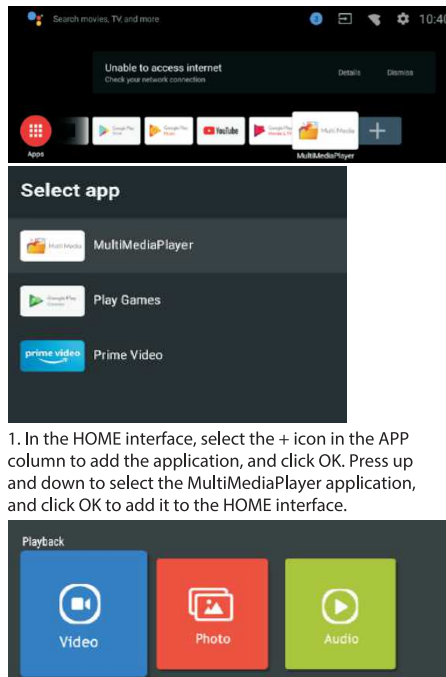

1. In the HOME interface, select the + icon in the APP column to add the application, and click OK. Press up and down to select the MultiMediaPlayer application, and click OK to add it to the HOME interface.

2. Select OK key to enter Multi Media Player and display Video, Photo, Audio. After inserting the usb flash drive, you can view the corresponding files in the usb flash drive.

NOTE

The menu/function may be different depending on when you purchased the TV.

SPECIFICATIONS

Viewing Picture Size (Diagonal)	55inch
Resolution	3840x2160
Aspect Ratio	16 : 9
TV System	PAL-B/G, SECAM-B/G, DVB-T, DVB-C
Video Signal System	PAL/NTSC/SECAM
Receiving Channel	DVB-T:1000, DVB-C:1000, ATV:99
Input PowerVoltage	100-240V~, 50/60Hz
Power consumption	150W
Audio Output Power(THD≤7%)	2 x10W
Signal input/output	High-Definition Multimedia Interface(HDMI) x4 Composite Video Input x 1 Audio Input x 1 LAN Input x 1 YCb(Pb)Cr (Pr) x 1 USB x 2 OPTICAL OUTPUT x 1 HEADPHONE OUTPUT x 1 RF x 1 TF x 1
Horizontal definition (TVline)	CompositeVideoinput>=350 YCb(Pb)Cr(Pr)>=400

Supported PC Input Signal

Your unit can use as PC monitor, it supports below RGB-PC, HDMI mode INPUT.

RGB-PC, HDMI mode INPUT SPEC				
VGA / HDMI Input				
	Resolution	Horizontal frequency (KHz)	Vertical frequency (HZ)	Standard
INPUT FORMAT	640x480	31.5	60	VGA
	640x480	37.86	72.809	VESA
	640x480	37.5	75	VESA
	720x400	31.5	70	VGA-T
	800x600	37.9	60	VESA Guidelines
	800x600	48.077	72.19	VESA
	800x600	46.9	75	VESA
	832x624	49.7	75	Mac
	1024x768	48.4	60	VESA Guidelines
	1024x768	60	75	VESA
	1152x870	68.68	75	Mac
	1280x800	47.8	59.8	—
	1280x960	60.0	60	VESA
	1360x768	47.7	60	VESA
	1366x768	47.712	59.79	VESA

SIMPLE TROUBLESHOOTING

If the display fails or the performance dramatically changes, check the display in accordance with the following instructions. Remember to check the peripherals to pinpoint the source of the failure. If the display still fails to perform as expected, contact the dealer for assistance.

Symptom	DEALING METHOD
No Power	Check the power connection. Pull the plug out, wait for 60 seconds, then reconnect the power and turn on the set.
No Sound	Increase the volume. Check if the set is on the mute state or not. Check the voice setting condition. Check the voice mode setting condition.
Remote not responding	Check the effect of the batteries. If necessary, replace the batteries or clean the remote control sensor window. The distance between the set and the remote control should be less than 6 meters.
Abnormal Color	Check the antenna connection.
TV set needs to be cleaned	Please pull the plug out when cleaning the screen. Use a soft, clean cloth to wipe it off. If needed to clean further, please use dry cloth, do not use naphtha or other thinners liquids.
System Error (For Smart TV only)	<ul style="list-style-type: none">• Retry current operation.• Enter the home page, and select "Restore Factory Setting" in the menu of System Setting. Do not cut off power during restore period.• Power off, then restart.





HOTLINE

- AUSTRALIA : www.soniq.com/au/contact-us
- NEW ZEALAND : www.soniq.com/nz/contact-us